

Please note that the data given here has been taken from the online catalog. For comprehensive information and data, please refer to the user documentation at <http://www.download.phoenixcontact.com>. The General Terms and Conditions of Use apply to Internet downloads.

▶ Extract from the online catalog

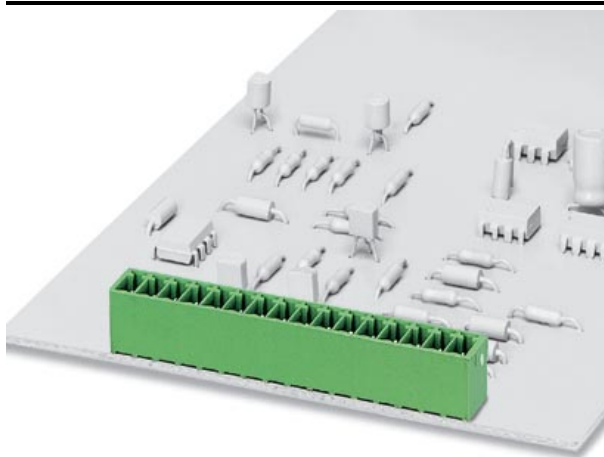

Header, nominal current: 8 A, rated voltage: 160 V, pitch: 3.81 mm, no. of positions: 7, mounting: Soldering

The illustration shows a 16-position version

Order No.	1803471
Ord designation	MCV 1,5/ 7-G-3,81
EAN	4017918045784
Pack	50 Pcs.
Customs tariff	85369010
Catalog page information	Page 109 (CC-2005)

▶ Technical data

Dimensions / positions

Pitch	3.81 mm
Dimension a	22.86 mm
Number of positions	7
Pin dimensions	0,8 x 0,8 mm
Hole diameter	1.2 mm

Technical data

Insulating material group	IIIa
Rated surge voltage (III/3)	2.5 kV
Rated surge voltage (III/2)	2.5 kV
Rated surge voltage (II/2)	2.5 kV
Rated voltage (III/2)	160 V
Rated voltage (II/2)	250 V
Connection in acc. with standard	EN-VDE
Nominal current I_N	8 A
Nominal voltage U_N	160 V
Maximum load current	8 A
Insulating material	PBT
Inflammability class acc. to UL 94	V0

► Certificates

Certificate logos



UL

Nominal voltage U_N	300 V
Nominal current I_N	8 A

CSA

Nominal voltage U_N	300 V
Nominal current I_N	8 A

► Drawings

Drilling diagram

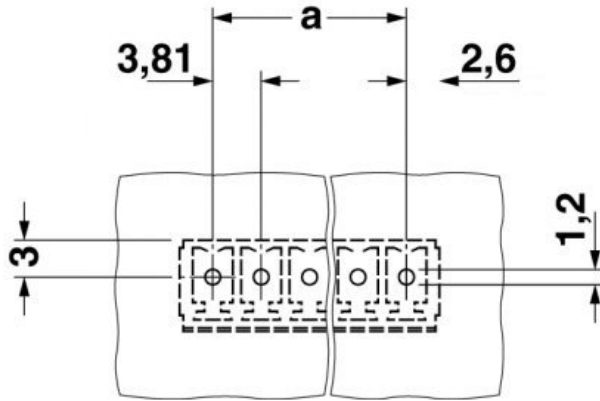

Dimensioned drawing

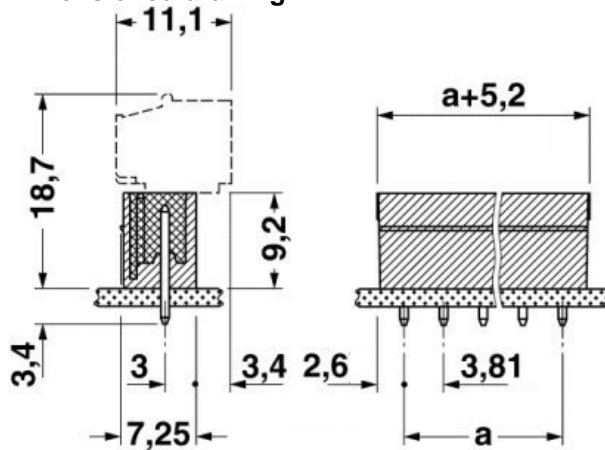

► **Accessories**

Item	Designation	Description
Marking		
1051993	B-STIFT	Marker pen, for manual labeling of unprinted Zack strips, smear-proof and waterproof, line thickness 0.5 mm
0804109	SK 3,81/2,8:FORTL.ZAHLEN	Marker card, printed horizontally, self-adhesive, 10-section marker strip, 14 identical decades marked 1-10, 11-20 etc. up to 91-(99)100, sufficient for 140 terminal blocks
0805056	SK 3,81/2,8:SO	Marker card, special printing, self-adhesive, labeled acc. to customer requirements, 14 identical marker strips per card, max. 25-position labeling per strip.
Plug/Adapter		
1734634	CP-MSTB	Coding section, is inserted into the slot on the plug or inverted header, red insulating material

► **Additional products**

Item	Designation	Description
General		
1851096	FK-MCP 1,5/ 7-ST-3,81	Plug component, nominal current: 8 A, rated voltage: 160 V, pitch: 3.81 mm, no. of positions: 7, type of connection: Spring-cage connection
1850712	FRONT-MC 1,5/ 7-ST-3,81	Plug component, nominal current: 8 A, rated voltage: 160 V, pitch: 3.81 mm, no. of positions: 7, type of connection: Screw connection
1862629	IMC 1,5/ 7-G-3,81	Header, nominal current: 8 A, rated voltage: 160 V, pitch: 3.81 mm, no. of positions: 7, mounting: Soldering
1875470	IMCV 1,5/ 7-G-3,81	Header, nominal current: 8 A, rated voltage: 160 V, pitch: 3.81 mm, no. of positions: 7, mounting: Soldering
1803620	MC 1,5/ 7-ST-3,81	Plug component, nominal current: 8 A, rated voltage: 160 V, pitch: 3.81 mm, no. of positions: 7, type of connection: Screw connection
1852228	MCC 1/ 7-STZ-3,81	Plug component, nominal current: 8 A, rated voltage: 160 V, pitch: 3.81 mm, no. of positions: 7, type of connection: Crimp connection
1827172	MCVR 1,5/ 7-ST-3,81	Plug component, nominal current: 8 A, rated voltage: 160 V, pitch: 3.81 mm, no. of positions: 7, type of connection: Screw connection
1827020	MCVW 1,5/ 7-ST-3,81	Plug component, nominal current: 8 A, rated voltage: 160 V, pitch: 3.81 mm, no. of positions: 7, type of connection: Screw connection
1897445	QC 0,5/ 7-ST-3,81	Plug component, nominal current: 8 A, rated voltage: 160 V, pitch: 3.81 mm, no. of positions: 7, type of connection: Insulation displacement connection QUICKON

► **Address**

PHOENIX CONTACT Inc., USA
586 Fulling Mill Road
Middletown, PA 17057
USA
Phone (800) 888-7388
Fax (717) 944-1625
<http://www.phoenixcon.com>
Phoenix Contact
Technical modifications reserved;